



Cobalt-S

the switch that
switches everything
controls it all

The Concept:

Bring a sense of reality to the control of model railways. Make a switch that has the look and feel of the railway with the quality in action that tradition requires. Make it easy, but don't compromise. Follow a traditional style, add the feel of quality and use quality materials that bring back the past. Make it versatile for use with any scale, any prototype and any technology the modeller chooses. Make one switch that looks better, works better and will do it all, no matter what is asked of it.

The Reality: Cobalt-S

Something special: 140mm (5-1/2") high and with a feel that has never been achieved before without long hours of skilled work on the modellers bench. A solid brass lever with working locking catch that gives a real feeling of action when moved, with a solidity and purpose reminiscent of the real thing. Added detail parts are also supplied with every switch.

Incredible versatility: A switch that switches EVERY electrical item ever created for use on a model railway, without exception... yet it is very easy to Connect and understand. A switch that will happily group together just like the prototype but also comes complete with a subtle added spacer for those with larger fingers. There are simply NO limits, so you can create a local control position or recreate the classic major signal box of a large yard or city station.

Solver of problems: No more need for special switches or special expensive add-ons to make things work in the way you want. Cobalt-S is the one and only device that will operate any form of point or turnout control device or signals and can simultaneously control interlocking, operate lights on a control panel and where needed, provide power control for live frog point-work.

Use a Cobalt-S to control traditional low cost solenoids, and problems disappear... or use with Cobalt digital or Cobalt Classic point motors and the possibilities for layout control will become almost infinite.

Universal usability: All things become possible with Cobalt-S whether you use solenoid or motor drive point motors, semaphore signals or colour lights or choose to operate with AC, DC or DCC power.

A product to enjoy: We have really thought about how you may want to use it, So wiring is clearly laid out and we have created a simple PCB connection as the hub of your wiring. Simple connection is described on each pack, and more complex wiring is explained in several of these simple manuals available online. Each Cobalt-S is supplied with several added parts to add detail and realism.

Cobalt-S is Available in singles, six and twelve packs...

Cobalt-S also comes with a comprehensive warranty so you can buy, install and use them with confidence. Additionally, we understand that accidents can happen no matter how careful you are... and we know that you'll be using your Cobalt-S for a very long time, so accessories and spare parts will always be on hand and available if you should ever need them.

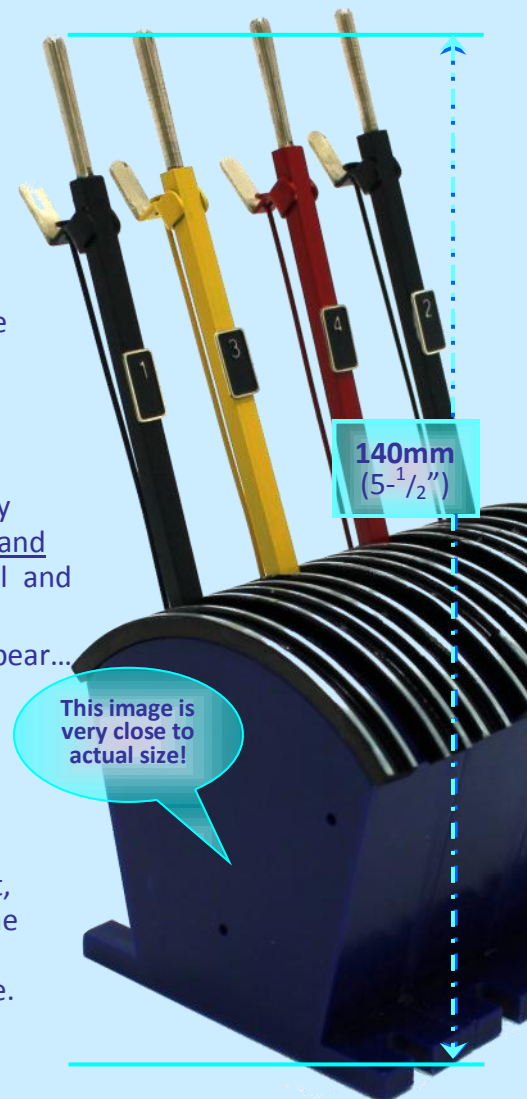



Cobalt-S

the switch that
switches everything

controls it all

Cobalt-S: what can it do.... the basics

Cobalt-S is a high quality “control lever” which has been created to allow a modeller to use ONE kind of switch to control ALL of the devices on his layout. It is equally usable for any scale, for any accessory whether AC, DC or DCC powered and any form of train control whether it be AC, DC DCC or proprietary systems such as Marklin.

There are a myriad of uses... either for dissimilar or linked operations: For example, one Cobalt-S could do all the following: change a solenoid point motor, switch the polarity of the frog, control associated panel lights and signals AND operate a “safety section” ahead of each frog rail to prevent a point being crossed without being correctly set.

Cobalt-S really CAN control anything that has ever been invented for use on a model railway.

Operation:

Cobalt-S uses a typical form of signal box lever design: The catch must be gripped and squeezed in order to release the lever, and released at end of throw to lock it in position. The pull is smooth and firm and locking is positive.

Onboard switching:

Momentary switches: Cobalt S includes a high-power handling SPDT momentary switch, suitable for any device needing only a pulse of power such as DCC accessory decoders, high or low power AC/DC solenoids or signals. Cobalt-S is therefore the perfect way to add traditional manual control of electrical devices - and it is also a great way to provide an optional control method for DCC accessory decoders that offer that choice.

Latching or On-On switches: Cobalt S includes TWO high-power handling “Break before make” SPDT On-On changeover switches that can be configured as either on-on or on-off switches, as well as being able to be used together to create a DPDT switch to control devices that need reverse polarity... or even select between program and main line power for a DCC layout. All Cobalt-S switching is able to handle high or low power switching at any common Model railway voltage.

Connection:

Cobalt-S has a simple to use replaceable plug-in 9 wire harness and it is also supplied with a clearly marked printed circuit board that tells you which wire goes where - so even for a novice, wiring is simplified.

Instructions:

The basics are covered by the instructions on the back of the product, and those with simpler applications or needs and modellers with a little experience will need no more than the basic data to be able to use Cobalt-S to do it all...

However... the potential is SO big that we do need to show off what it can do... Without making the use of Cobalt-S look too intimidating! Therefore, we will break down “Working and wiring with Cobalt-S” into several simpler manuals and we are now preparing the first of them, each covering a single subject, as follows: **THIS is MANUAL 1**

- (1) **Manual 1 - Cobalt-S basics: All about Cobalt-s, how to dress it for realism and basic wiring instructions.**
- (2) **Wiring Solenoids & Momentary devices with Cobalt-S, including panel lights & switched frog power.**
- (3) **Wiring Cobalt and similar devices, including panel lights, safety interlocking & switched frog power.**
- (4) **Conditional operation: Interlocking signals and pointwork or pointwork and control options.**
- (5) **Interfacing with digital devices, thinking laterally and problem solving.**
- (6) **The importance of proper power supplies in pointwork switching and overall layout control.**

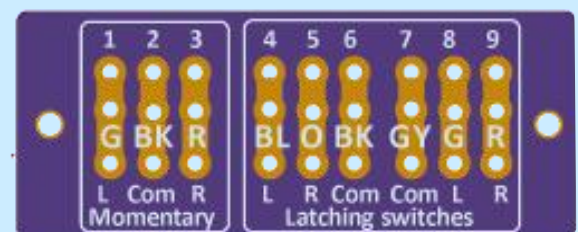



Cobalt-S

the switch that
switches everything

controls it all

Cobalt-S: what is included in every pack....

Cobalt-S is the star... A high quality lever with realistic action able to switch absolutely anything. The lever is solid brass, and it has been specially treated to look good and also act as an excellent "key" for you to do as the real railways do, painting it the correct colour for its intended use (Colour chart is included on Page 8 of manual).

Of course, to get the look right, the handle itself should have that polished look, so we'll expect you to add a shine to it... we tell you how to do that on page 7. The case is a tough engineering plastic and inside are custom created phosphor bronze contacts - 3 sets of them, able to change any device you will ever use on your layout.

Of course in order to enhance realism while also making it easy to connect... each pack contains far more than just a **Cobalt-S** switch... We have added lots of accessories too!

A wiring Harness:

Cobalt-S is supplied with a replaceable 9 wire harness designed to plug in to the switch and make wiring easier. It is colour coded and long enough to allow you to mount the switch with all connections out of sight. We know you will have your Cobalt-S for a long time, so the harness is available as an accessory in packs of 3, with 3 PCBs. (ref: DCP-CSA).

A Connection PCB:

Cobalt-S is also supplied with a clearly laid out, easy to solder to connection PCB to act as the interface between The Switch and the layout. Each PCB wire position is clearly labelled indicating the appropriate connection and wire colour so you can easily pre-wire your accessories without guesswork. The PCB also has screw mounting holes.

A set of "Etched Brass" numbers:

Every lever in every signal box has a number, and yours can too. We've included a set of high quality etched brass numbers with each lever and for larger applications we have also made an accessory pack including 99 different numbers so no matter how big your application every lever can still have its own number. (ref: DCP-CS99).

Two pairs of metal top ribs:

While some levers were surrounded by a smooth cover to the frame top, many we found when researching had a much more interesting "ribbed" surround, which was part of the lever guide system. While we could have chosen to make this in the same plastic as the lever casing, we thought that a genuine metal frame top would look fantastic... And it does. Each pack includes two of them, blackened, ready for you to polish their tops to a shine and apply them to your Cobalt-S levers.

A useful Spacer:

When dimensions are scaled, spacing that is "right" can easily become a bit of a struggle for large fingers... So we have included the answer to fat fingers with each lever. The 3mm spacer simply clips to the lever side, adding another few millimetres so you can easily grasp and use the lever as intended. They can of course also be used in multiple to create gaps between "groups" of levers if you wish to separate them by purpose or category...

And even the screws are provided in the pack...

Of course a large lever like Cobalt-S will need fixing in place. To make that easy we have even included the screws you will need... So from the moment you open the package, you have all you need to complete the job.





Cobalt-S

the switch that
switches everything
controls it all

The Cobalt-S ...Pack contents and Accessory kits

Cobalt-S Switch - Part number DCP-CBS

Cobalt S can be used as is but the pack contains some really nice dress-up parts too, so you can make it something very special and uniquely yours if you wish!

The single pack contains the following:
(6 & 12 packs contain correct multiples)

- Lever x 1
- Spacer x 1
- Mounting screws x 2
- Harness x 1
- Wiring PCB x 1
- Etched Brass Numbers x 6
- Ribbed top castings x 2



99 etched brass numbers - Part number DCP-CS99

Able to cope with even the largest Lever frame, these quality etched brass numbers will also find a home on many control panels as ID numbers for points and signals. *We've painted a few to show you how good they can look!*

SIX AND TWELVE PACKS ARE ALSO AVAILABLE

Six and Twelve packs contain an appropriate "Signal lever" quantity plus a pro-rata quantity of all accessory items.

Of course, these packs also save you some hard earned hobby money by offering a lower per-lever cost too.

Part numbers: 6-pack DCP-CBS6, 12-Pack DCP-CBS12



Cobalt-S cosmetic parts. Part number DCP-CSP

If you need only a few more etched brass numbers, this pack contains lever number plates 1~12.

Additionally, in case you lose or even damage the cast metal lever "Ribs", we have added 3 pairs to this pack.

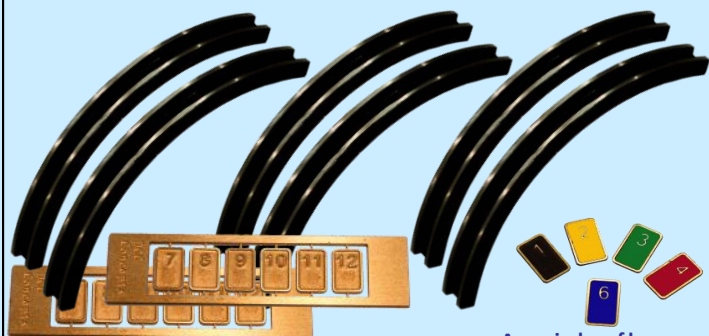

A reminder of how good these look when painted

Three Spare Harnesses, Three Spare PCB's and Nine mounting screws.

Part number DCP-CSA

With Cobalt-S designed to last for a very long time, most modellers will change the layout several times in the time they own them.

This "connection pack" makes sure that all of the parts that might be needed will be to hand if and when they are needed.





Cobalt-S

the switch that switches everything

controls it all

Cobalt-S: the wiring basics....

The image to the right shows the wiring basics. The harness is shown in the same orientation as it will look when plugged into Cobalt-S, with the three "momentary contact switch" wires at the top. The PCB you will receive with Cobalt-S will be printed just like this illustration, so you will be able to use the PCB itself as a permanent on-layout "reminder"

Re Switch types and name abbreviations:

- * "Momentary contact" means that the wire is only powered for a short time.
- * "SPDT" means "single pole double throw"
- * "On-On" means the power stays on in each direction

Description and purpose of each wire on Cobalt-S:

- (1) Green wire. Left coil of solenoid or left momentary contact.
- (2) Black wire. Common wire for momentary contacts.
- (3) Red wire. Left coil of solenoid or left momentary contact.
- (4) Blue Wire. Left contact for SPDT On-On switch #1
- (5) Orange Wire. Right contact for SPDT On-On switch #1
- (6) Black Wire. Common contact for SPDT On-On switch #1
- (7) Gray Wire. Common contact for SPDT On-On switch #2
- (8) Green Wire. Left contact for SPDT On-On switch #2
- (9) Red Wire. Right contact for SPDT On-On switch #2

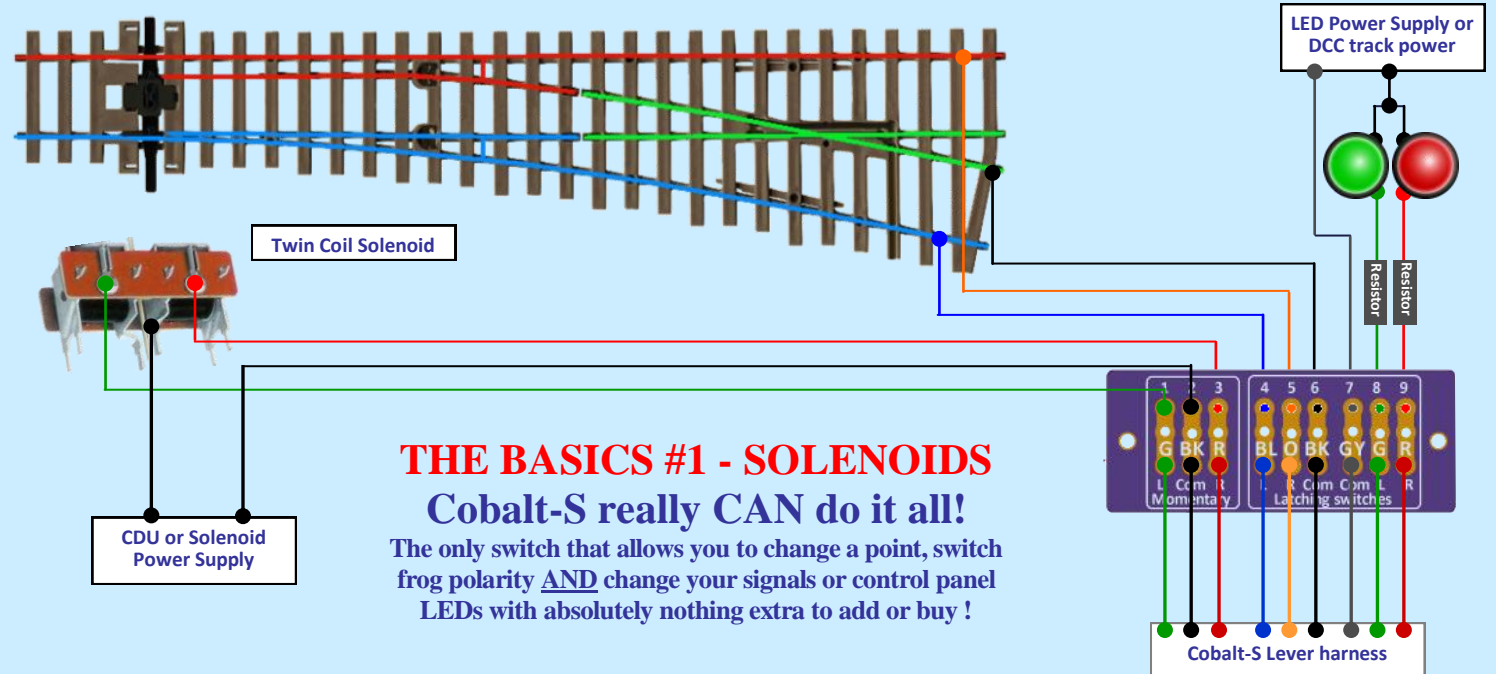
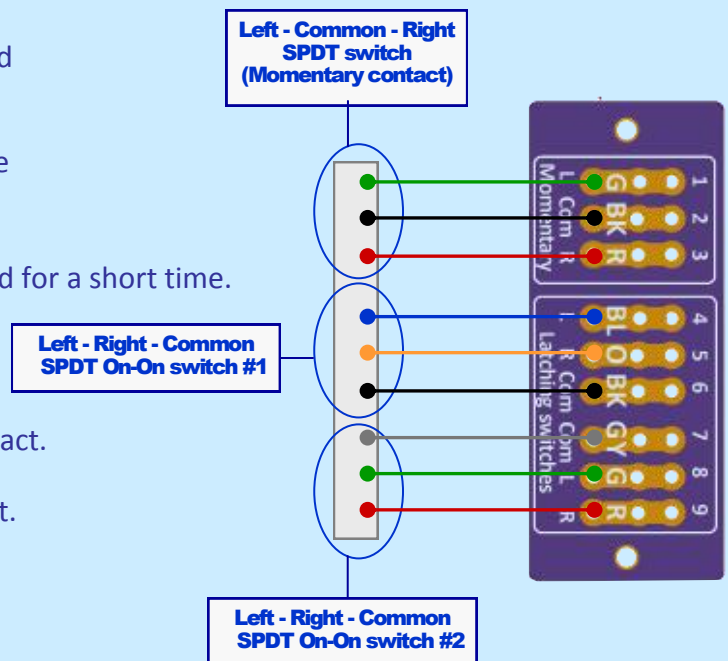

THE BASICS #1 - SOLENOIDS

Cobalt-S really CAN do it all!

The only switch that allows you to change a point, switch frog polarity AND change your signals or control panel LEDs with absolutely nothing extra to add or buy !

Cobalt-S

the switch that
switches everything
controls it all

Cobalt-S at its best....

It can be as simple or as complex as you want it to be. The Cobalt-S switch is already able to switch any item ever invented for use on a model railway...
PLUS - If you combine Cobalt-S with a Cobalt point motor then you really can have it all - and all at once too!

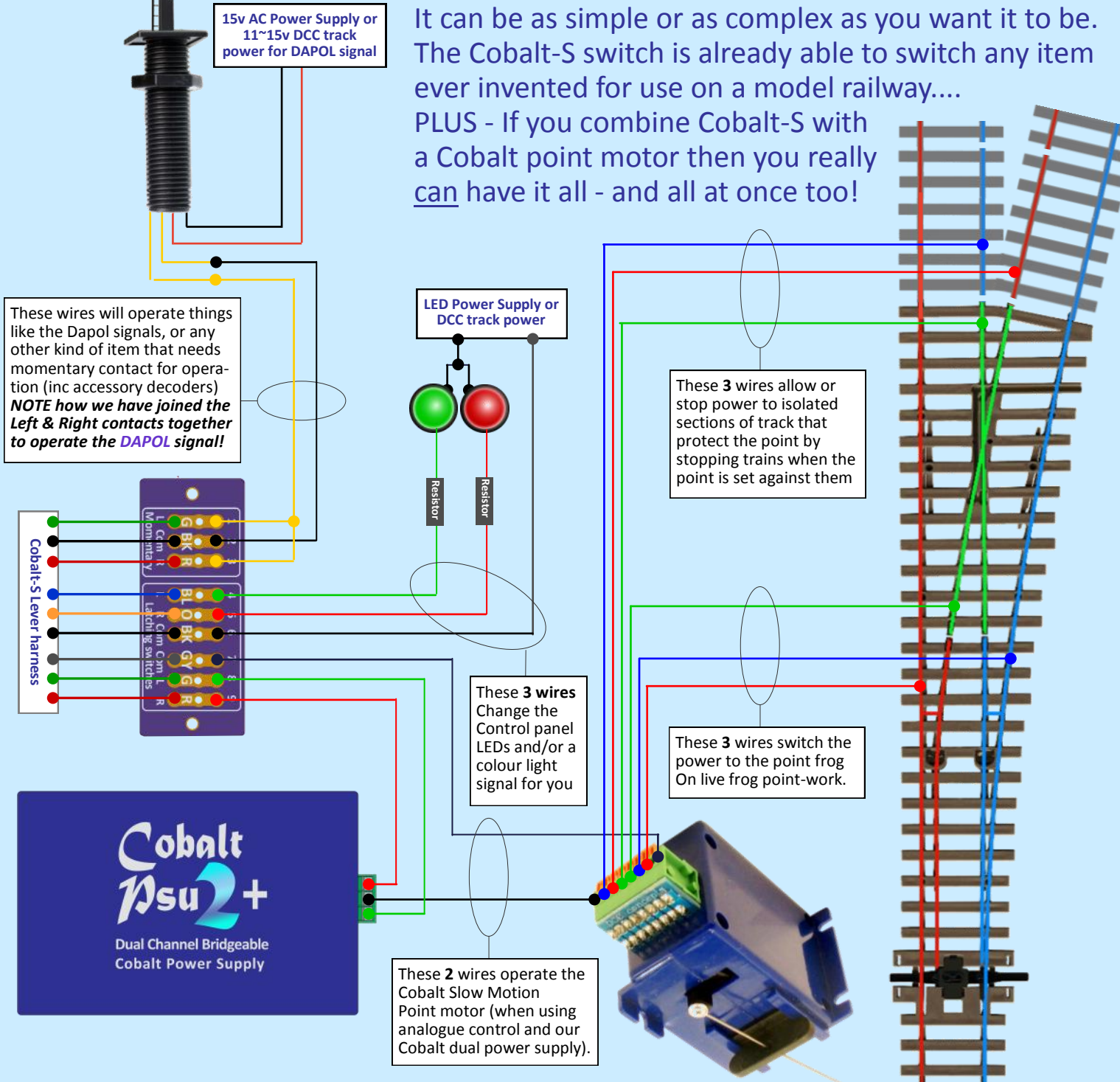



Cobalt-S

the switch that
switches everything

controls it all

Adding the detail to Cobalt-S to make it special:

With **Cobalt-S**, as well as creating a very clever switch that can literally control any electrically operated item that has or will be invented for model railways, we also set out from the beginning to bring a sense of reality and add some “prototypical fun” to the control of your models.

Of course, **Cobalt-S** can be used just “as is” straight out of the box to operate any item at all on your model railway, but for those who want that little bit extra... Please read on as we detail how we see **Cobalt-S** being prepared for use as a “realistic signal box lever”, one step at a time.

First, the planning:

Work out where the levers will be placed, create a flat area to mount them and decide how you will configure them. The space will need to be approximately 75mm deep to comfortably accommodate the levers - and a little deeper to allow space if you also want to mount the connection PCBs in a neat and tidy fashion.

Each lever will need the following space: (The individual lever footprint is as per this diagram)

Mark out the area using the levers themselves as a template or using the dimensions shown in the drawing on the right of this page. Don't forget to add 3mm for each spacer you intend to use.

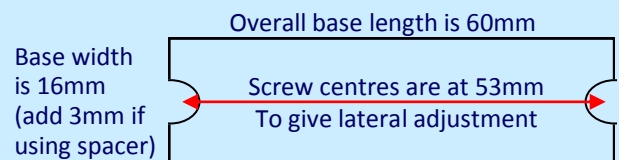

The harness and connection PCB.

Each lever has a harness that exits the lever on the rear face and the harness has leads that are 150mm long, so the connection PCB can be positioned up to about 135mm from the lever itself. The PCB's themselves are each 20mm x 43mm, with mounting holes along the centreline that are spaced 33.5mm apart (for #4 pan head screws or similar). Plan where you will place the PCBs after soldering them to the harness. You COULD now just continue, connect & use them, but why not make them as realistic as possible..

Preparing the Brass levers - Colour.

Each lever should be painted in the correct colour for the task it will perform. If you want to use prototypical colours, there is a useful chart on page 10 of this manual.

Otherwise, make your choice and paint carefully. ONLY down to the top of the plastic case & do not get paint inside the lever. (Each lever is pre-prepared to take paint well)

Preparing the Brass levers - Polishing.

The one thing that is really noticeable with all signal-box levers is the very smooth and shiny polished handle, worn that way by constant use. To get the same effect, using fine wet and dry abrasive paper (1000 grit +), polish the brass handle to a nice shine.

Touching up the Blue Lever Casing.

First, paint the ends and edges of the plastic top with matt black paint. Leave a little area each side of the top so that glue will stick the black cast ribs securely - Glueing is always best when done on an unpainted area.

Finally, select the lever that will be at the END of the lever bank and if you want it to match the colour of the top castings, paint the outer face a matt black (if you will use the “signal box mounting” on page 9 of this manual, then you need only paint the top part of the arc).





Cobalt-S

the switch that
switches everything

controls it all

Adding the detail to Cobalt-S... Continued

The Lever top detail casting.

Each lever is supplied with 2 x metal "Rib" castings. Polish only the top surface of the "ribs" until they shine, using the same wet and dry material you used on the lever. When happy with them, glue to each side of the lever top, making sure that they are flush with the outside edge of the lever AND slightly overhang the top evenly each side. Be sparing with the glue.

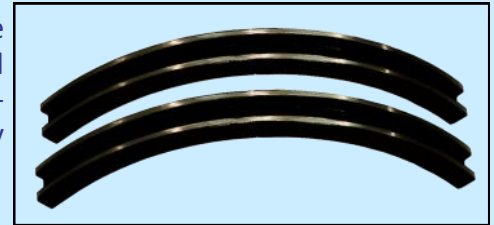

Preparing the etched Brass lever numbers:

All **Cobalt-S** switches are provided with finely etched brass lever numbers.

Each single pack and six pack contains the number 1 to 6. 12 packs contain the numbers 1 to 12. We have also made an accessory pack that contains 1 to 99.



Wash the brass fret with a fine abrasive cleaner, or clean it with a fibreglass brush. Rinse and dry, then fill the recessed area with your chosen colour. A couple of coats of aerosol paint is fine. Don't worry about paint on the face of the numbers at this point. We recommend gloss enamels or similar for best adhesion and hardness.

Let the paint dry for at least 24 hours. Now, thoroughly wet the same sort of "Wet and dry" 1000 grit paper that you previously used on the lever handle and rib castings and place it on a smooth flat surface, abrasive face up.

Cut numbers from the fret carefully & file smooth any remaining brass "tabs".

Place the prepared numbers FACE DOWN on the Wet and dry paper and using light pressure from your finger or thumb, gently move it back and forth until you have polished away excess paint.

Check often and before long you will have a perfect brass number with a brass frame and richly coloured background that looks great!

Place the brass number BACK DOWN on the wet and dry and polish the back a bit so it will take glue well later. Now give the number a good wash and let dry. You may wish to add a clear coat to the face to prevent tarnishing.



Applying the etched Lever Numbers:

When properly dry, use a little superglue, epoxy or contact adhesive and glue it to the front face of the lever, using pictures of prototype levers as a reference.

NOTE: If you want to use a more complex numbering system then you can...

Use your computer to create really small labels the same size as the etched brass number plaques, have them laser printed, cut them out and mount them with an appropriate glue to the smooth inner lower part of the brass labels... (It is probably better to do this after gluing the brass plaque to the lever shaft).

Alternate method of applying your etched brass plaques:

Soldering the numbers to the levers is also possible of course, as both the lever and plaques are of brass. If you are confident and quick with a soldering iron, solder first, clean up, paint lever and then add paint to the face of the number, polishing off any excess paint later with 1000 grit or finer wet and dry paper used wet. The choice is yours!



Cobalt-S

the switch that
switches everything

controls it all

INTERIM INFORMATION ONLY

Making the installation something special:

Coming soon... As a laser cut kit that can be joined to make a larger box... (it'll very likely be plastic not wood as per this sample picture)

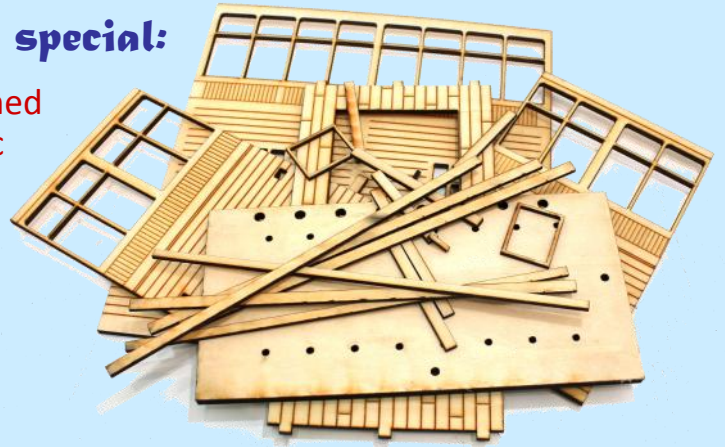

The final cost is TBC





Cobalt-S

the switch that
switches everything

controls it all

Summary of standard signal box lever colours (General UK railway practice)

Lever Colour	Main lever function	Notes
Yellow	Distant Signal	(also used for temporary collars to indicate electrical isolations)
Red	Stop signal, Ground signal	Also route levers
Blue	Facing point lock	
Black	Points, scotch blocks, de-railers	Also quadrants and catch blocks
Blue Top/Black lower	Combined point/facing point lock	
Brown	Barriers, Gate, Bridge & TT locks	Also wicket gates
Green	Gongs & asking lever	Distant signal colour up to 1930 (appx)
White	Spare lever, Fixed lever	Lever white if related apparatus removed
Red top/Brown lower	Acceptance lever	
Stripes Brown + white	King Lever	
Chevron Black/White	Detonator placer apparatus	Warning detonators for fog apparatus
Red top with Chevron Black/White lower	Signals combined with detonator placer apparatus	
Red top/Yellow Lower	Combined home and Distant signal	
White top, other colour below (various)	Lever left to retain locking or out of use with locking still attached	Lever top also shortened
Addition of a white band	Remote release possible	Indicates that the lever can be released from another signal box

Please Google "Signal lever colours" for specific information related to your prototype as details may vary a little

Cobalt-S has a 1 year warranty:

Cobalt-S is guaranteed to perform as it should for a period of one year from the date of purchase. Of course, being made with high quality parts it will give many years of service with minimal wear providing it is treated with respect.

Cobalt-S has been made using a solid brass lever, a tough engineering plastic case, high quality internal PCB's and precision tooled phosphor bronze switch contacts. Engineered for long life, Cobalt-S is also fully serviceable.

Accessories are available should you lose or damage them. We pride ourselves in always having available a full range of reasonably priced service parts should your lever be damaged or fail to perform as it should at any time.

Service and accessory kits or parts are available from DCCconcepts or Gaugemaster Controls Ltd., DCCconcepts United Kingdom distributors, who are also able to offer quality after-sales servicing for your Cobalt-S lever should it be required.

